



Hammond Power Solutions Inc.

TITLE: 3PH DISTRIBUTION TRANSFORMER
NAMEPLATE INFORMATION

3	21/07/16	PP	EDB UPDATE	DES: JWEN
2	20/03/17	PP	SEISMIC UPDATE	DATE: 15/11/09
NO.	DATE	BY	REVISION	SCALE: NTS

SHEET 1 OF 3

EDBSC3A0015DB

3.0 Jwen 2021/07/16 12:53



Hammond Power Solutions
Guelph, ONT Compton, CA

HPS Sentinel™ G
Energy Efficient Distribution Transformer
Transformateur de Distribution à Bon Rendement Énergétique

Baraboo, WI Monterrey, MX

Part No. **SG3A0015DB**



LISTED



LISTED

DRY TYPE TRANSFORMER 77US E112313

LR 3902

0342312309

ALSO REFER TO ENERGY STANDARDS C002-18 BY UNDERWRITERS LABORATORIES INC. @ 316

SPACINGS BETWEEN ANY VENTILATED ENCLOSURE PANEL AND ANY ADJACENT WALL SHALL BE A MINIMUM OF 3 INCHES

VOLTS	CURRENT COURANT	% RATED % TENSION NOMINALE	CONNECTION EACH PHASE CONNECTION PAR PHASE
252	34.4	105	1
246	35.2	102.5	2
240	36.1	100	3
234	37.0	97.5	4
228	38.0	95	5
222	39.0	92.5	6
216	40.1	90	7

Serial No. []

HV/HT 240V

BIL 36.1A

10 kV

Term Bornes H1 H2 H3

LV/BT 208Y/120V 41.6A

10 kV

Term Bornes X0 X1 X2 X3

Energy Regulations DOE 10 CFR PART 431:2016

Reglements de l'Énergétique CEE ACT SOR/2018-201

Encl. Type 3R

Type de Coffrage 175/80

Weight lbs/kg 175/80

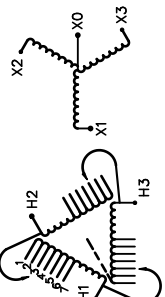

SEISMIC QUALIFICATIONS:
OSP=01.36-10/IBC 2018/ASCE 7-16
SDS<=2.0g Z/h=1 Ip=1.5

d000186hb

FRONT VIEW

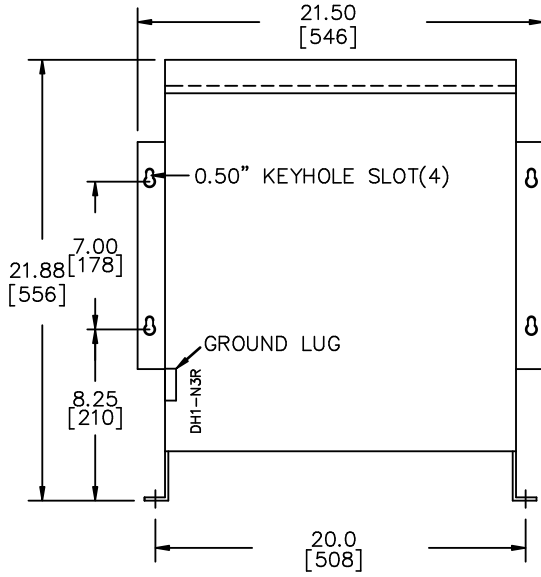

SIDE VIEW

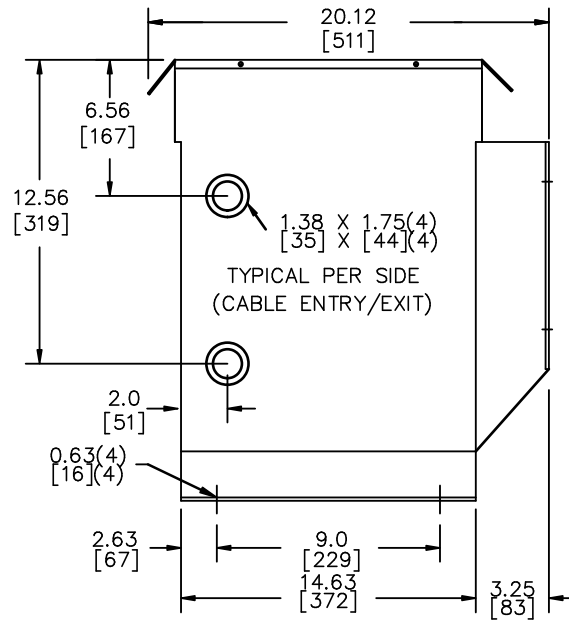

All Dimensions in inches[mm]

ENCLOSURE COLOR : ANSI-61 GREY PAINT OUTDOOR

HV TERMINAL DETAIL

LV TERMINAL DETAIL

MECHANICAL TYPE LUGS INCLUDED
SUITABLE FOR #14-2 CU/AL
CONDUCTORS
1 CONDUCTOR PER PHASE

MECHANICAL TYPE LUGS INCLUDED
SUITABLE FOR #14-2 CU/AL
CONDUCTORS
1 CONDUCTOR PER PHASE

CUSTOMER NOTES:

- HV TERMINATED AT TOP FRONT
- LV TERMINATED AT BOTTOM FRONT



TITLE: 3PH DISTRIBUTION TRANSFORMER

3	21/07/16	PP	EDB UPDATE	DES: JWEN
2	20/03/17	PP	SEISMIC UPDATE	DATE: 15/11/09
NO.	DATE	BY	REVISION	SCALE: NTS

SHEET 2 OF 3

EDBSC3A0015DB

3.0 Jwen 20/07/16 12:53

ENCLOSURE BOTTOM VIEW

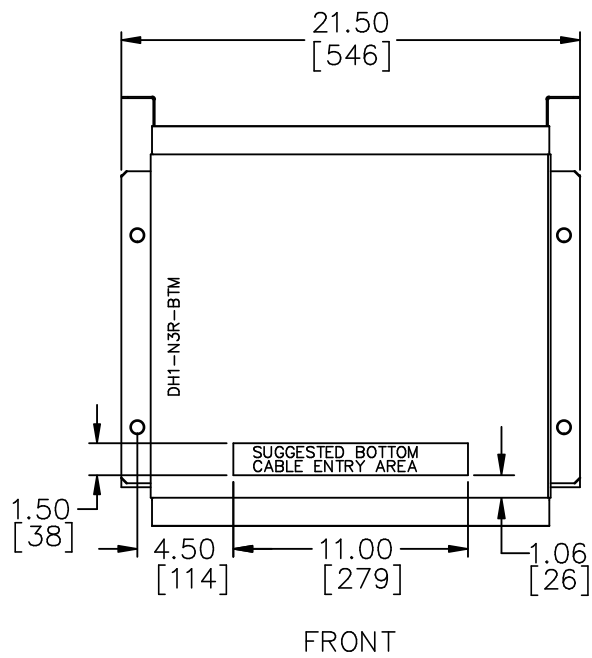

FRONT

NOTE:
 WHEN BOTTOM CABLE ENTRY IS OPTED, THE SPACE USED FOR CONDUITS IN THE FRONT OF THE TRANSFORMER SHOULD NOT OBSTRUCT MORE THAN 50% OF THE FRONT AIR INTAKE AREA DEFINED BETWEEN THE BOTTOM PLATE AND THE SUPPORTING LEGS.
 SEE MANUAL FOR ADDITIONAL INFORMATION



TITLE: 3PH DISTRIBUTION TRANSFORMER
 ENCLOSURE BOTTOM VIEW

3	21/07/16	PP	EDB UPDATE	DES: JWEN
2	20/03/17	PP	SEISMIC UPDATE	DATE: 15/11/09
NO.	DATE	BY	REVISION	SCALE: NTS

SHEET 3 OF 3

EDBSC3A0015DB

3.0 jwen 2021/07/16 12:53